

OCTOBER 2023

Fire Safety Gazette



Did you know that cooking fires are the leading cause of home fires and home fire injuries?
Cooking safety starts with YOU.

Pay attention to fire prevention.™



**FIRE
PREVENTION
WEEK™**

fpw.org



Message from Fire Marshal



It's my pleasure to present you and your child our 2023 Fire Safety Gazette. This year's Fire Prevention Week theme is "Pay attention to prevention. Cooking safety starts with you". Please use this Gazette as a helpful tool to learn together with your family about fire safety. Use the stories, puzzles, and games in this gazette to talk about your fire prevention and cooking safety in your home, to make sure everybody gets out safely! This year's theme is important-everyone should know how to prevent fire while cooking.

When you hear the smoke alarm, it's time to get out! Walk through your home with your family and identify multiple exits out of each room in the house. If windows or doors are blocked, clear them so they can be easily accessed and opened to exit through. It's always recommended that you have 2 exit routes from every room in your house. Once you get out of your home-have a safe place to meet up and meet the fire department when they arrive.

Parents-practice escaping with your young ones. Make them familiar with how to open a door or window and show them where you'll meet. Teach them to close doors behind them, crawl low if it's smoky, and to never, ever go back in. Remind them not to bring anything with them-those items can be replaced!

The Office of the Fire Marshal along with our Fire Departments are dedicated to the safety of New Brunswickers. This important week is a partnership with Insurance Brokers Association of New Brunswick-our major sponsor of the Fire Chief for a Day draw. Every child who completes a ballot included with this Gazette has a chance to be drawn as New Brunswick's Fire Chief for a day in the fall of 2023.

Fire safety begins at home with working, properly installed smoke alarms. Learn the sounds of fire safety, and know what to do!

Michael Lewis,
Fire Marshal



https://www2.gnb.ca/content/gnb/en/departments/public-safety/law-enforcement-and-inspections/content/fire_marshal.html

The Fire Safety Gazette is published by the Province of New Brunswick
P.O. Box 6000, Fredericton NB E3B 5H1 | www.gnb.ca
ISBN 978-1-4605-3099-3 (printed) ISBN 978-1-4605-3100-6 (online)
ISSN 2561-8873 (printed) ISSN 2561-8881 (online)
23-00476 | 2023.09
Printed in New Brunswick | Ce document est également publié en français.



We would like to congratulate this year's "Fire Chief of the day" for 2022, Christine Bastarache from the Gagetown School in Gagetown, NB.

Christine is a student from the grade two class. To celebrate this occasion, she was surrounded by her classmates from her grade 2 class along with her parents. Christine was presented with her firefighter turnout gear and a backpack filled with fire safety accessories from Fire Chief Ryan McNally of the Gagetown Fire Department along with Fire Marshal Michael Lewis of the Office of the Fire Marshal, and special guest Sparky the Fire Dog.

Christine and her classmates got to celebrate with a giant cake and to top things off, she got to take a drive in a big red fire truck around the village with lights and sirens.

A great day was had by all who attended.

For a chance to be chosen as chief for the day please be sure to fill out your ballot in this year's Fire Safety Gazette!

**Awards... Prizes... Celebration... Sparky...
Fire Trucks... Fire Fighters... Gear... Fun!
EXCITING! You could be this year's winner!**

Enter your name in the draw for a chance to have a special day like Christine! Fill out the ballot on the page 4.

OCTOBER 2023

Fire Safety in the Kitchen

Parents and caregivers – cooking is the number one cause of home fires. By following these safety tips, you can prevent fires and injuries.

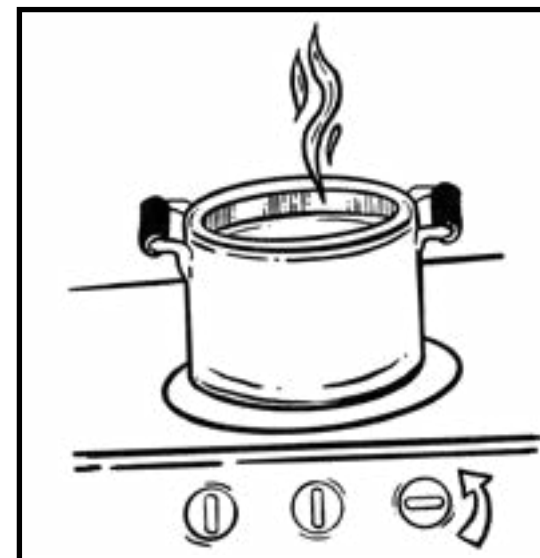

Watch what you heat! Stay in the kitchen when you are cooking food on the stove. Turn off the burner or oven if you leave the kitchen.

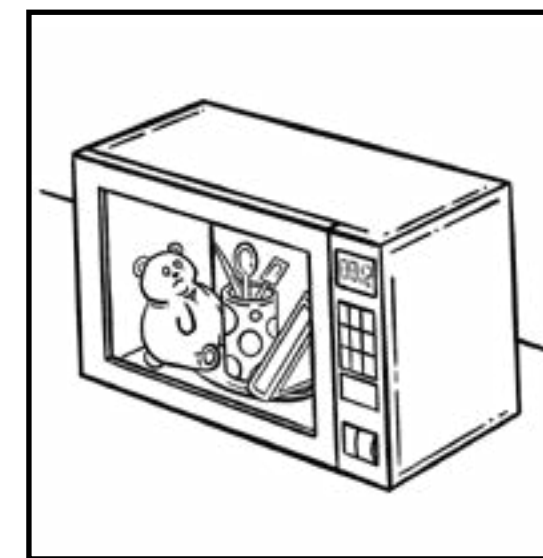

Keep things that can catch fire away from heat sources. Never use your oven or microwave as storage space.

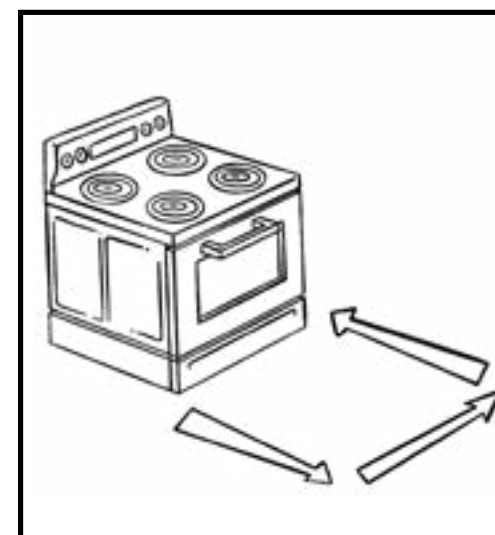

Kids should be 3 feet (1 metre) away from areas where hot foods or drinks are being prepared or carried.



Keep a lid nearby when you are cooking. If a small grease fire starts in a pan, smother the flames by sliding the lid over the pan. Turn off the burner. Do not move the pan. To keep the fire from restarting, leave the lid on until the pan has cooled.

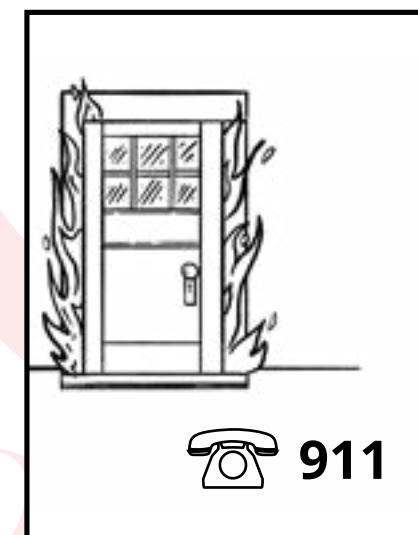

When in doubt, just get out! When you leave, close the door behind you to help contain the fire. After you leave, call 9-1-1 or the fire department from a mobile phone or a trusted neighbor's phone.

Kitchen Safety Game

Get cooking! In the first picture, cross out everything in the kitchen that is unsafe. In the second picture, circle everything you see that is safe. When you are finished, colour in the safe picture.

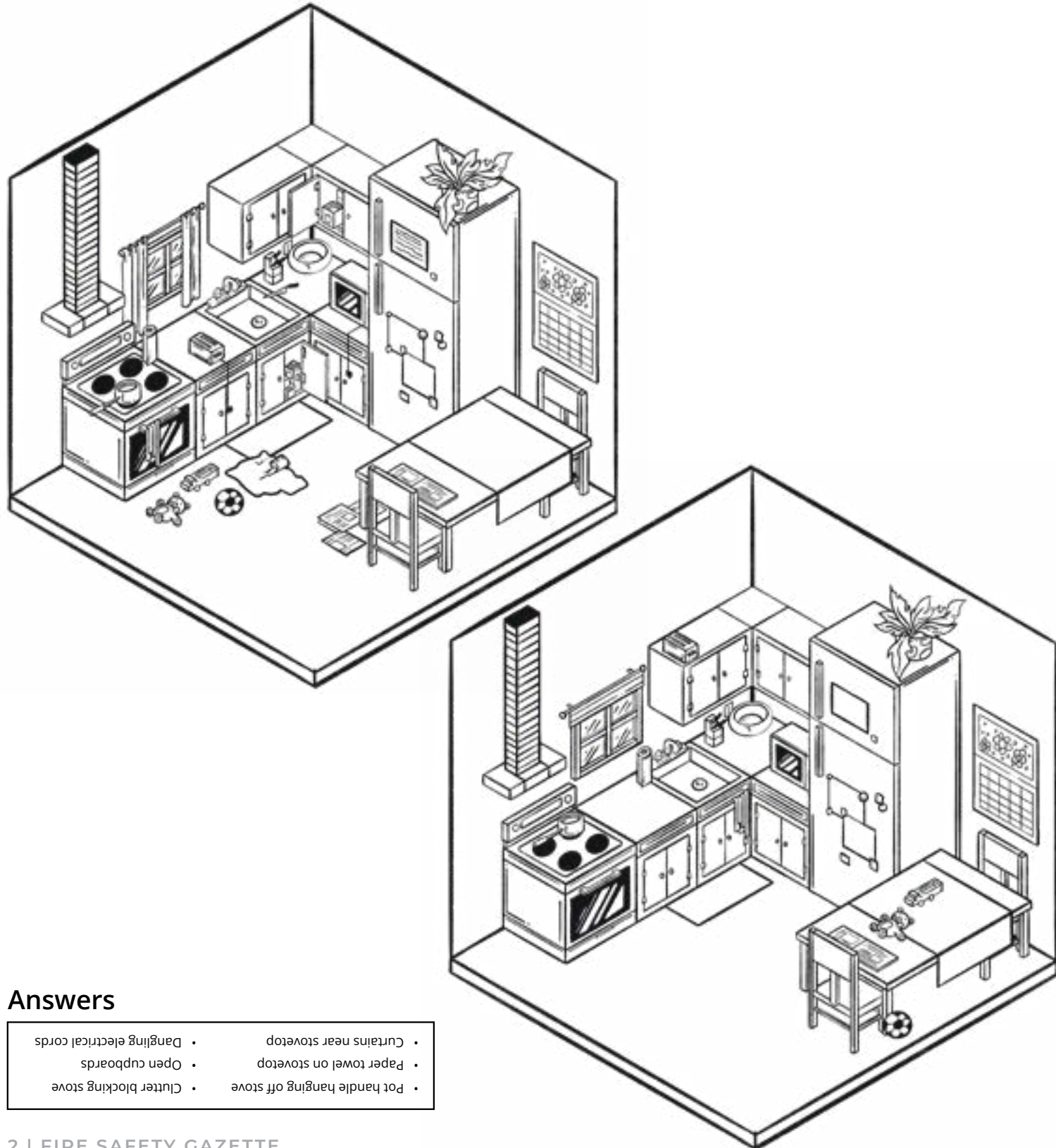

Answers

- Pot handle hanging off stove
- Clutter blocking stove
- Open cupboards
- Paper towel on stove
- Curtains near stove
- Dangling electrical cords

Maureen the Dog

Get colouring! Colour in Maureen the Justice and Public Safety fire investigation dog.



Fire Truck

Get colouring! Colour in the fire truck.

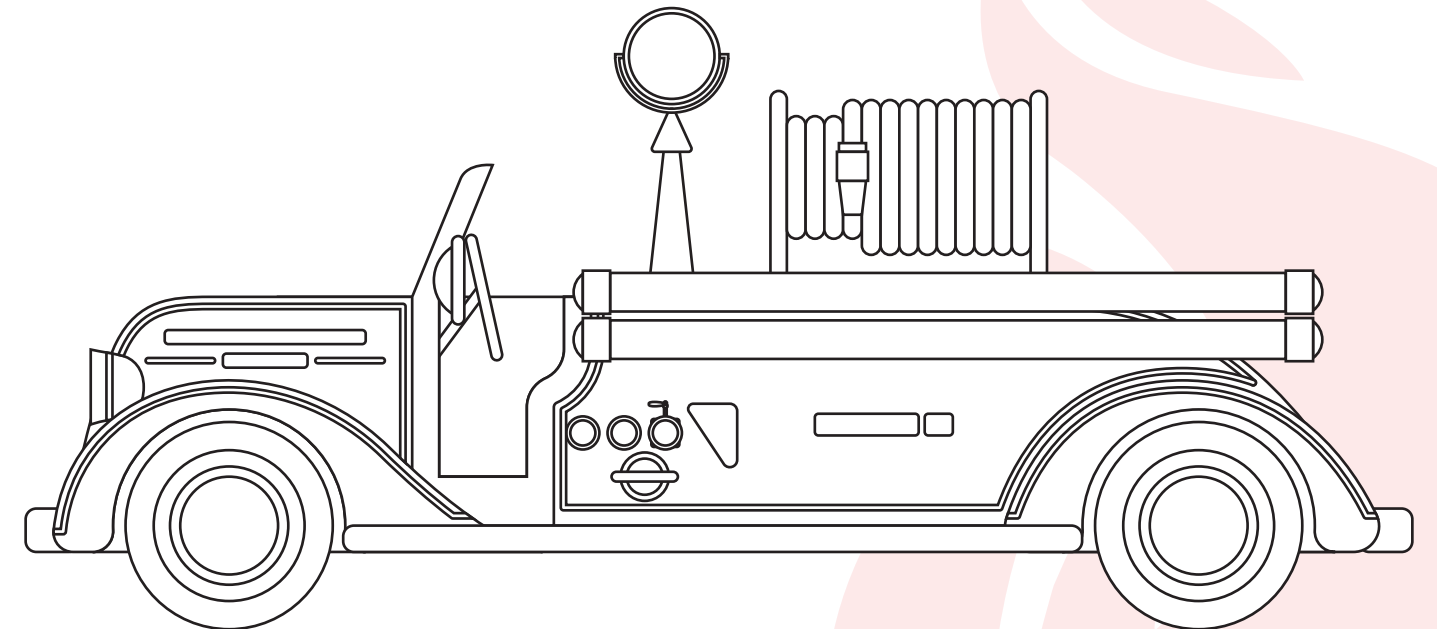

Fire Safety Word Search

f	i	r	d	e	t	r	w	a	t	e	r
c	s	t	o	p	k	c	s	t	r	o	d
r	r	m	g	p	l	r	o	r	u	p	s
l	d	r	o	p	n	a	f	d	c	h	t
l	c	o	a	k	a	w	n	i	k	o	a
o	a	l	l	r	e	l	t	o	r	s	t
a	r	l	d	a	e	s	c	a	p	e	i
w	e	k	a	y	h	e	l	m	e	t	o
s	h	y	d	r	a	n	t	g	e	p	n
l	m	o	h	m	m	r	e	s	c	a	h



stop drop roll crawl smoke alarm escape station
 plan fire truck hose water dog hydrant helmet

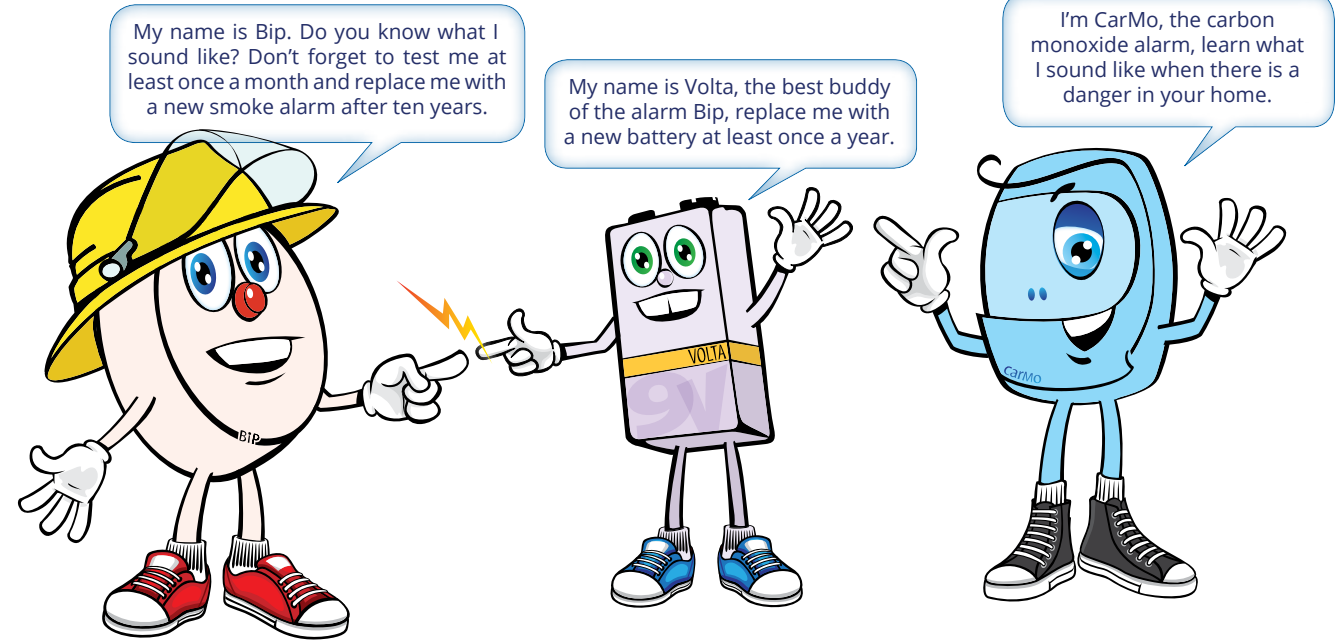

My Escape Plan

Draw your home escape plan.

On the floor plan, label each room. Locate windows, doors and stairways. Indicate your meeting place.

Fire Chief For-a-Day

ENTRY FORM

PLEASE PRINT CLEARLY

Student's name _____ Student's age _____

Grade (please circle) **K 1 2 3 4 5**

Teacher _____

School _____

School's address _____ Postal code _____

Only one entry per student.

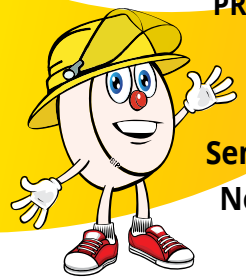

Send in before
 November 3rd
 2023

Send By Fax: 506 457-4899 / By email: fire.marshall@gnb.ca or by mail to:
 New Brunswick Office of the Fire Marshal, 12 McGloin St., Gibson Place,
 Fredericton, NB E3A 5T8

Home Fire Safety Checklist

Go from room to room and answer the questions below. Give yourself one point for each "yes" answer. When you're done, add up the points to find out how fire safe your home is.

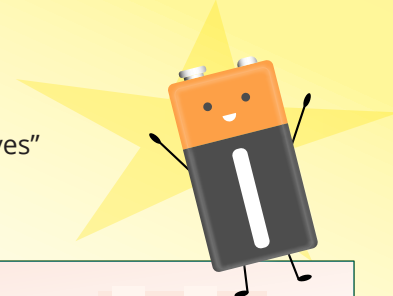

Smoke Alarms / Home Fire Escape

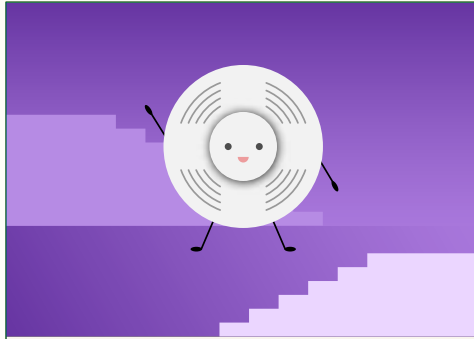

Are there smoke alarms on every level, including the basement and outside each sleeping area?

Yes No

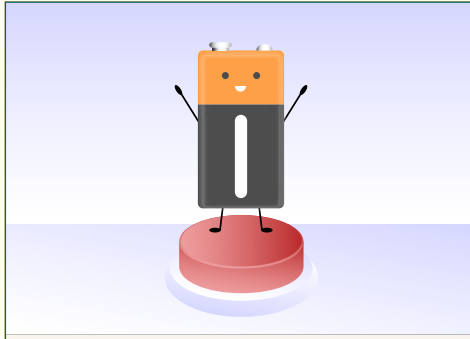

Are there batteries working in all your smoke alarms? (Have a grown-up push the test buttons to find out.)

Yes No

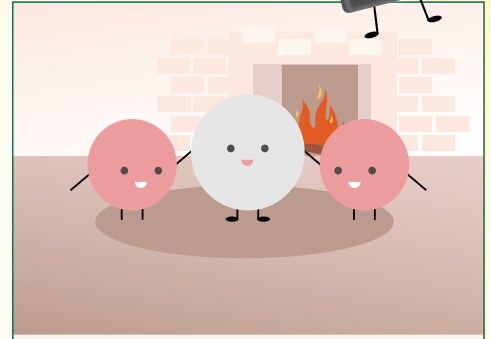

Do you have a carbon-monoxide detector installed if you are burning wood, propane or natural gas?

Yes No

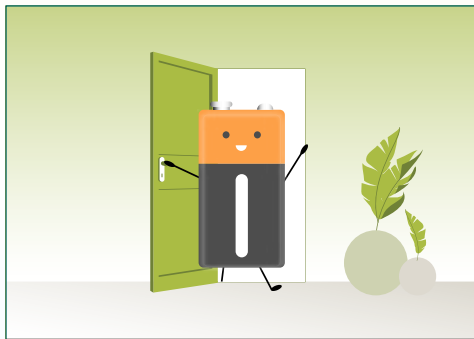

Are all the exits in your home clear of furniture, toys and clutter?

Yes No

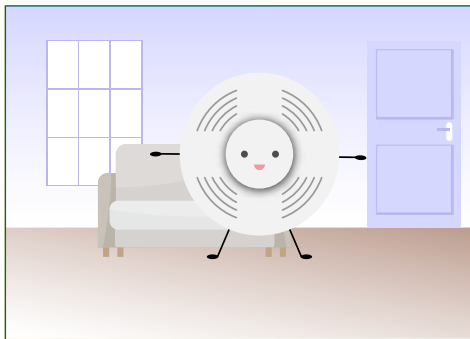

Does your family have a home fire escape plan that includes two exits, usually a door and a window, from each room?

Yes No

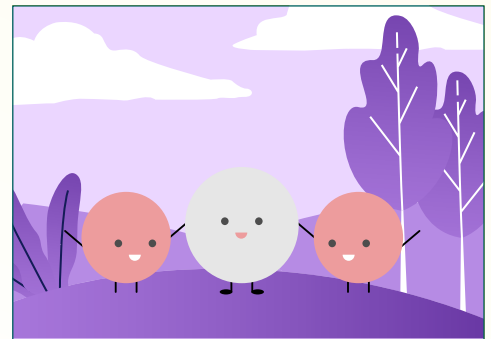

Has your family picked a safe place to meet outside after you exit your home?

Yes No

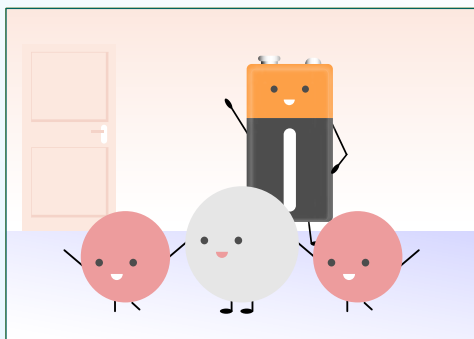

Have you practiced your home fire drill within the last six months?

Yes No

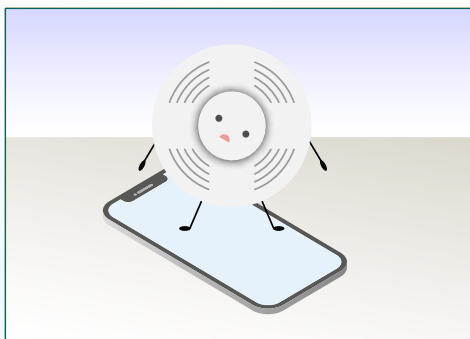

Do you know what phone number to call in the event of a fire?

Yes No

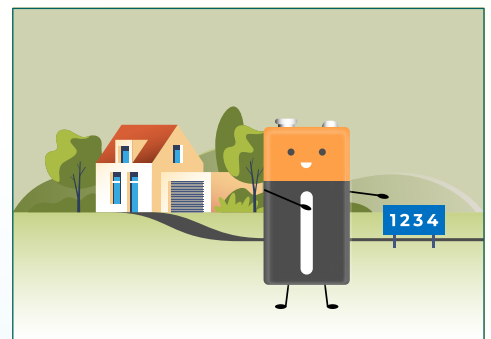

Can your house or building number be seen from the street?

Yes No

What's your fire safety score?

- If you answered "yes" to all of the questions, congratulations! You've done your homework for fire safety.
- If you've answered "yes" to 6 to 8 questions, you're going in the right direction, but you've got some work to do.
- If you answered "yes" to fewer than 6 questions, have a look around and make the changes you need so that your home is fire-safe!

